

BERZERKER QUICK GUIDE

Use Board Layout: UA4C

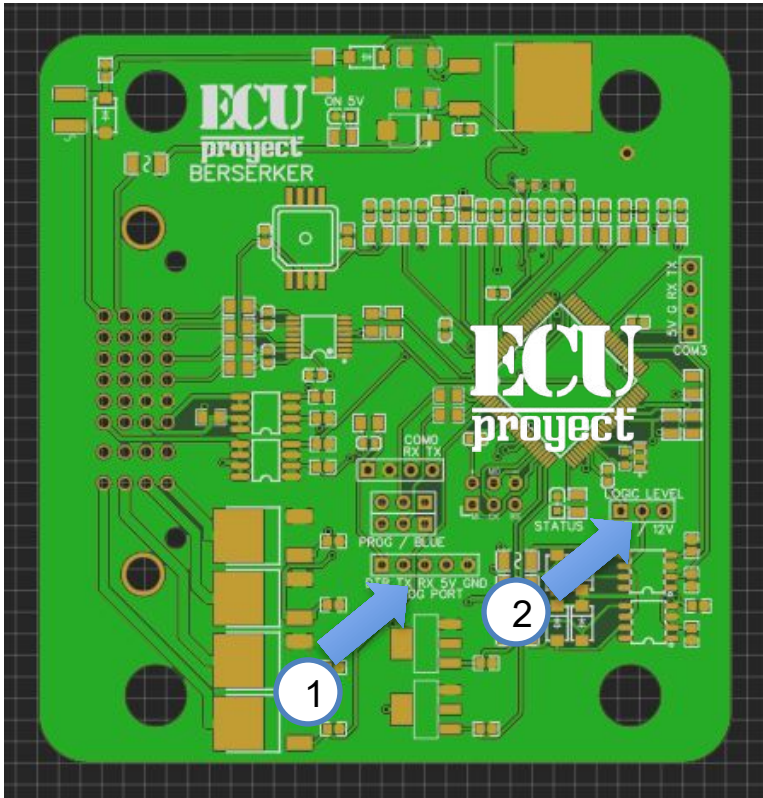

Jumpers (selectors)

- 1.- Port and selector to burn firmware
- 2.- Selector to choose ignition outputs at 5V or 12V

The ECU comes in VR mode, to connect a hall sensor you just have to place a Pullup resistor!

- 12V.- power supply for ECU (normally to switch)
- GND.- ground, the ground is common for sensors, and other devices
- 5V.- 5V output for sensors (TPS, MAP)
- INJ1, INJ2, INJ3, INJ4.- Injection banks 1,2,3 and 4
- IGN1, ING2, IGN3, IGN4.- Ignition banks 1,2,3 and 4
- FLX.- input for Flex Fuel sensor (ethanol content)
- IAT.- air intake temperature sensor
- CLT.- coolant temperature sensor
- TPS.- throttle body position sensor
- LNCH.- input to activate launch control (IT IS ACTIVATED WITH GND OF THE SAME ECU)
- O2.- input for oxygen sensor (wideband with controller or narrowband straight)
- O2_2.- input for second oxygen sensor (wideband with controller or direct narrowband)
- VSS.- configurable digital input (nitro, speed, etc)
- BRO.- input for Barometric sensor (MAP of 1 bar)
- VR1+.- crankshaft sensor input or CKP type OPTICAL or HALL (add pullup) also configurable as positive pulse VR
- VR2+.- OPTICAL or HALL type tree or CAM sensor input also configurable as positive pulse VR
- VR1-.- is only used in case of configuring crankshaft sensor as VR type, this is the negative complementary pulse input
- VR2-.- it is only used in case of configuring tree sensor as VR type, this is the negative complementary pulse input
- FAN 1,2.- outlets for radiator fan (use with relay)
- FP.- output for fuel pump (use with relay)
- TACH.- tachometer output
- BST.- outlet for Boost Control valve
- VVT.- output for variable shaft
- OUT26.- medium power output available
- OIL.- for logging of pressure sensor

INTEGRATED VR card

4 bar internal map

Programmable via Bluetooth

BERZERKER QUICK GUIDE

Berzerker

| A | B | C | D | E | F | G | H | |
|-------|------|------|--------|-----|-------|------|------|---|
| 1VR2+ | VR2- | VR1- | VR1+ | GND | OUT26 | IGN1 | INJ1 | 1 |
| 2O2 | TPS | OIL | LAUNCH | GND | TACH | IGN2 | INJ2 | 2 |
| 35V | CLT | BARO | FLX | VVT | FP | IGN3 | INJ3 | 3 |
| 412V | IAT | O2_2 | VSS | BST | FAN | IGN4 | INJ4 | 4 |

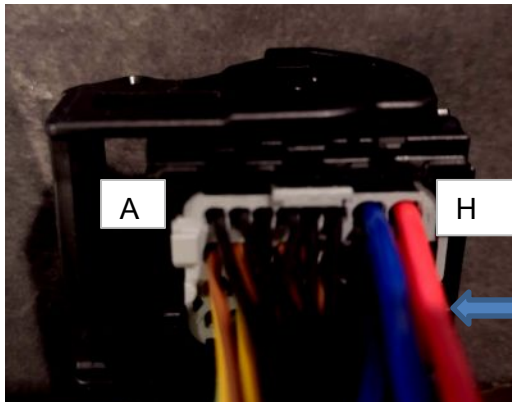

Big Pins

colors may vary

ECU project

www.facebook.com/ProjectECU/

CAVEAT

Do not record tunes or megasquirt files in this ECU, this ecu IS NOT MEGASQUIRT, it is not clone of megasquirt either. Therefore, recording an incompatible tune will cause the ecu not to synchronize time and failures will occur.

RECOMMENDATION:

Follow the Tutorial1 and the virtual drive files to connect to the ECU and do the Hardware test!
Do this before you install the ECU!

How to assign extra inputs or outputs?

Some menus have something called “pin”, this is used to assign this function to another available output.

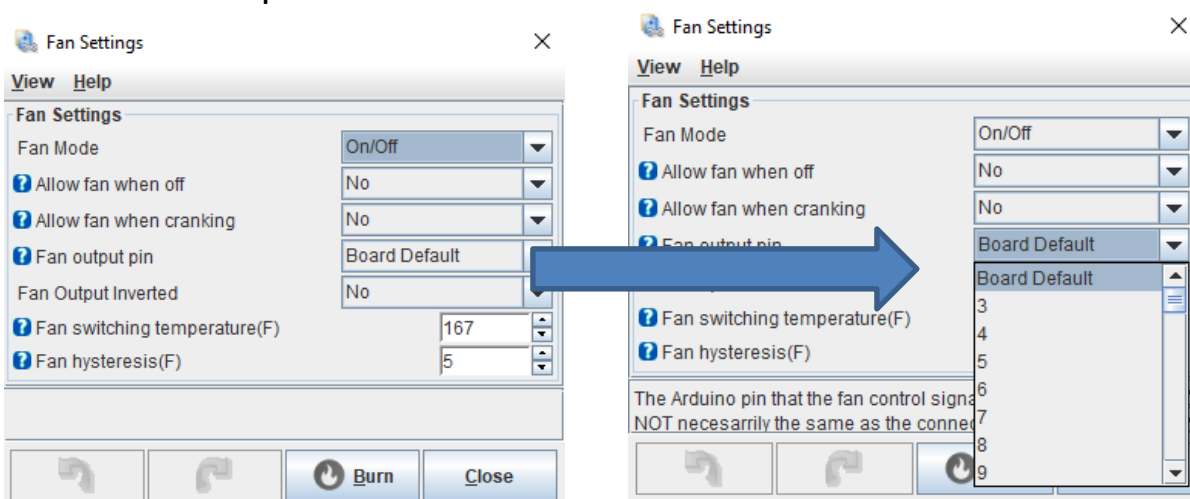

Use this table to find out which pin each reassignable output has.

Berzerker:

| | |
|---------|------------------------|
| Inputs | Baro.- A7 (Analog) |
| | O2.- A1 (Analog) |
| | O2_2.- A9 (Analog) |
| | OIL.- A6 (Analog) |
| | Flex.- 20 (Digital HS) |
| | VSS.- 21 (Digital HS) |
| Outputs | Launch.- 37 (Digital) |
| | Out26.- 26 (2amp) |
| | BST.- 12 (3amp) |
| | VVT.- 11 (3amp) |

MAPconnection

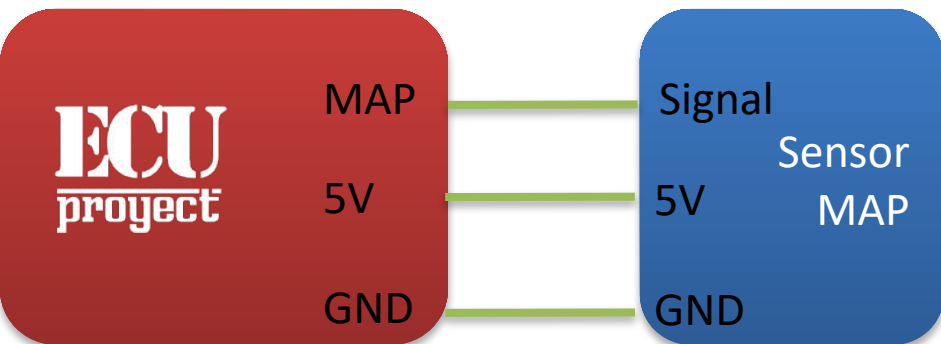

IAT or CLT connection

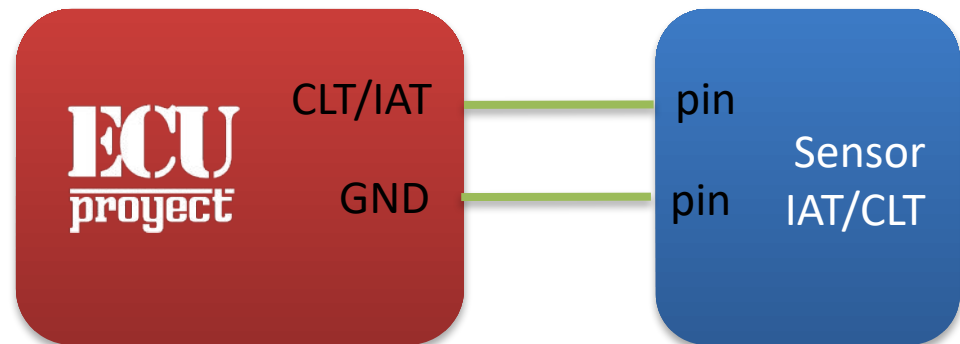

TPS connection

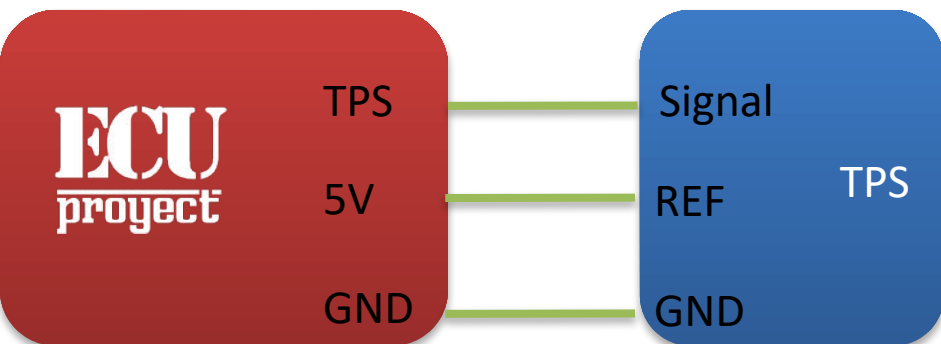

Launch Control Connection

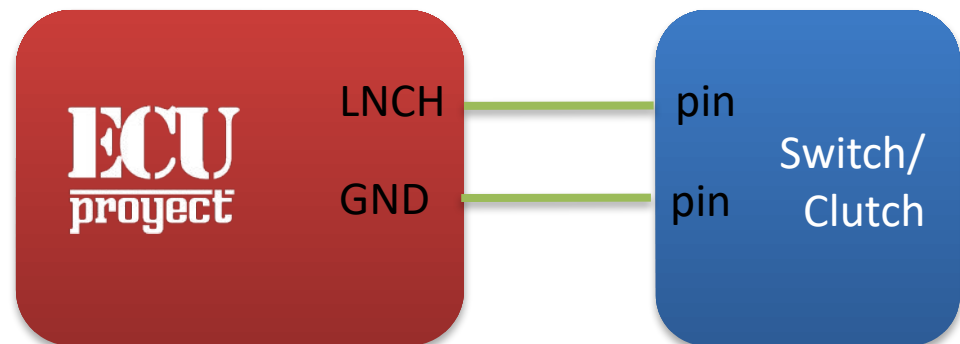

Ignition Connection (Coil)

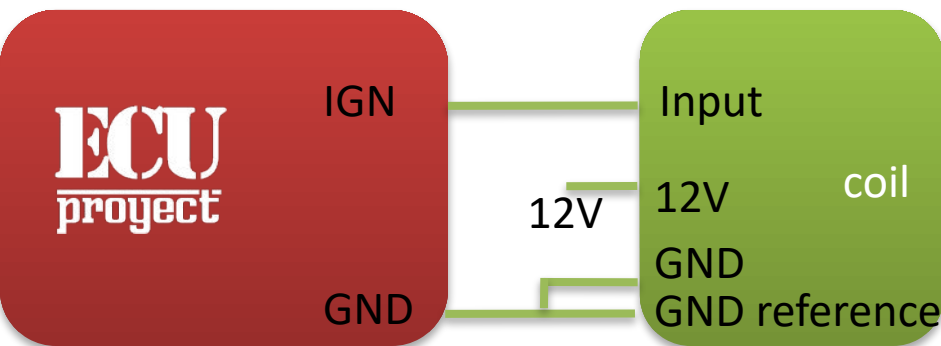

Injector connection

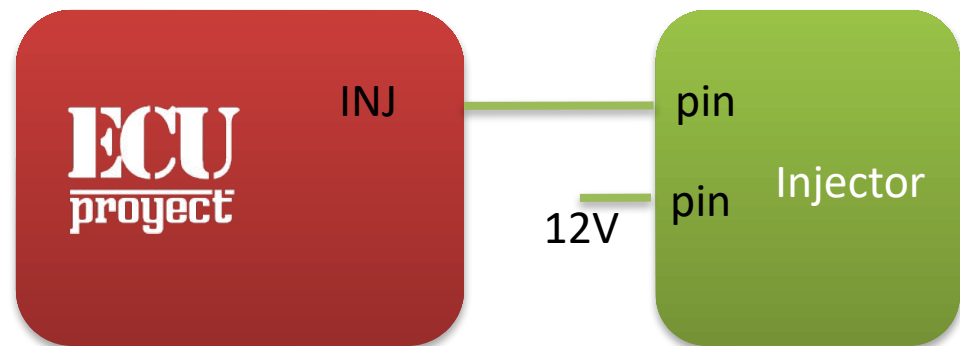

WIDEBAND connection (with gauge)



Narrowband O2 sensor connection

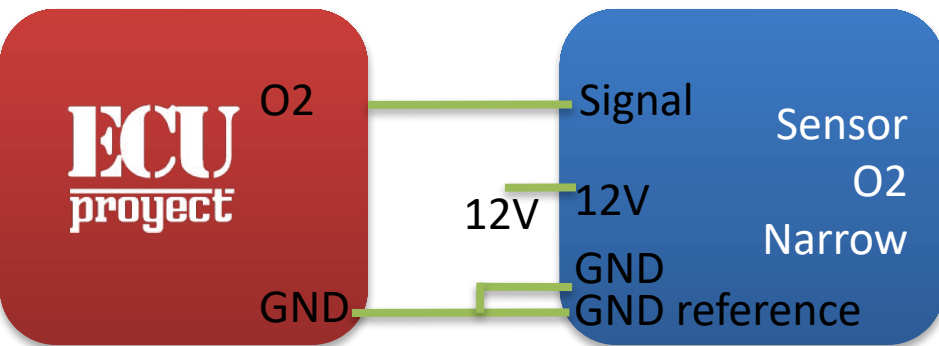

FP connection (with relay)

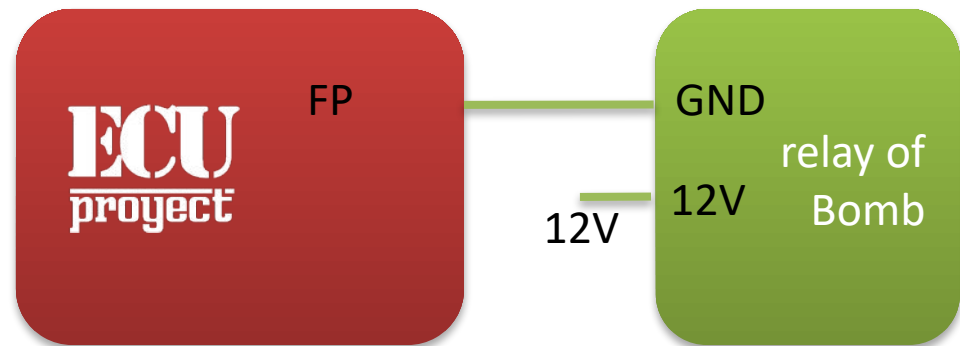

FlexFuel connection

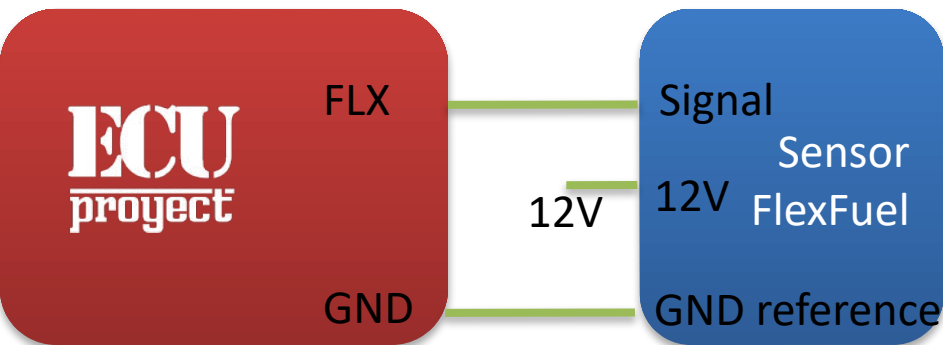

FAN connection (with relay)

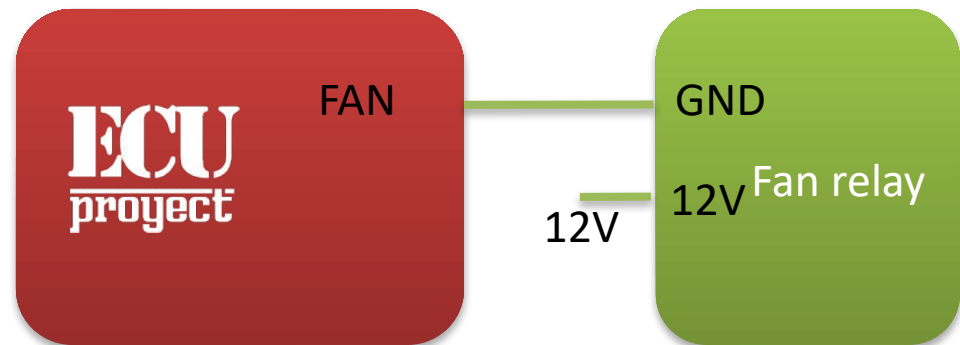

VR Type CKP Sensor Connection

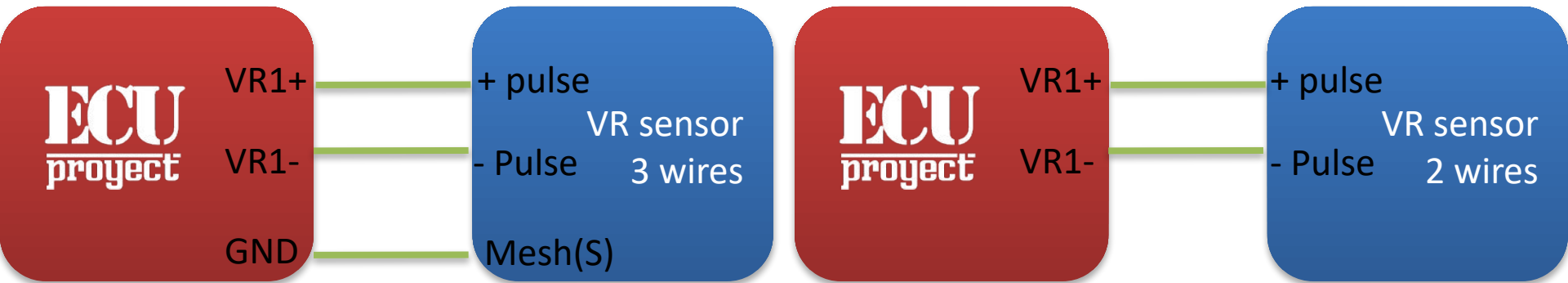

Hall/Optical CKP Sensor Connection

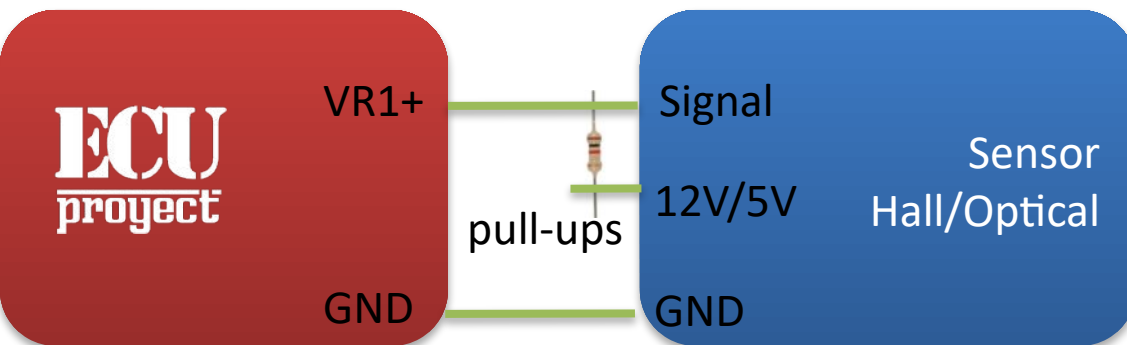

Pullup: Resistance from 1k to 10k. Not all Halls require Pullup (for example those of LS)

Tachometer Connection

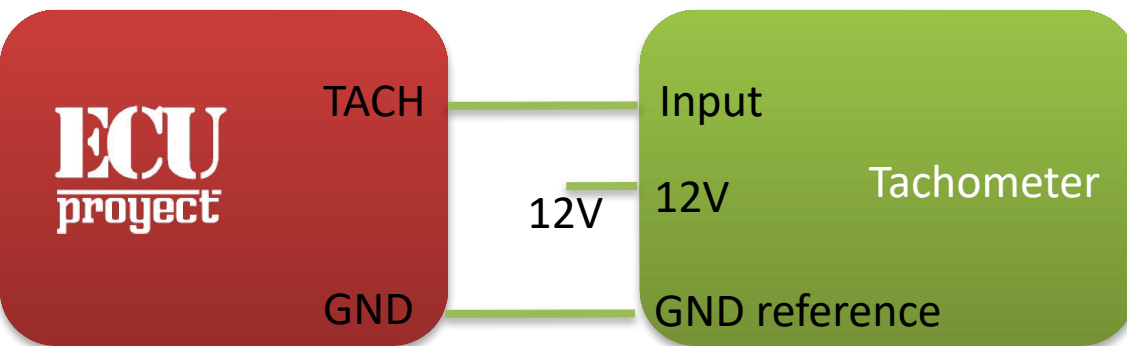

How to find the signals of my VR sensor

There are 2-wire and 3-wire VR sensors, in the case of the 2-wire ones it is easy to connect them, but for the 3-wire one there is confusion because we have a cable that has no signal and can cause failures.

To find which is the pair of signals, a multimeter is used to measure ohms.

Take a pair of pins and place the multimeter, if the resistance is infinite then we have that we are taking a signal pin and a mesh pin

We change pins until it gives us a resistance between 0.8k ohm to 1.5k ohm.

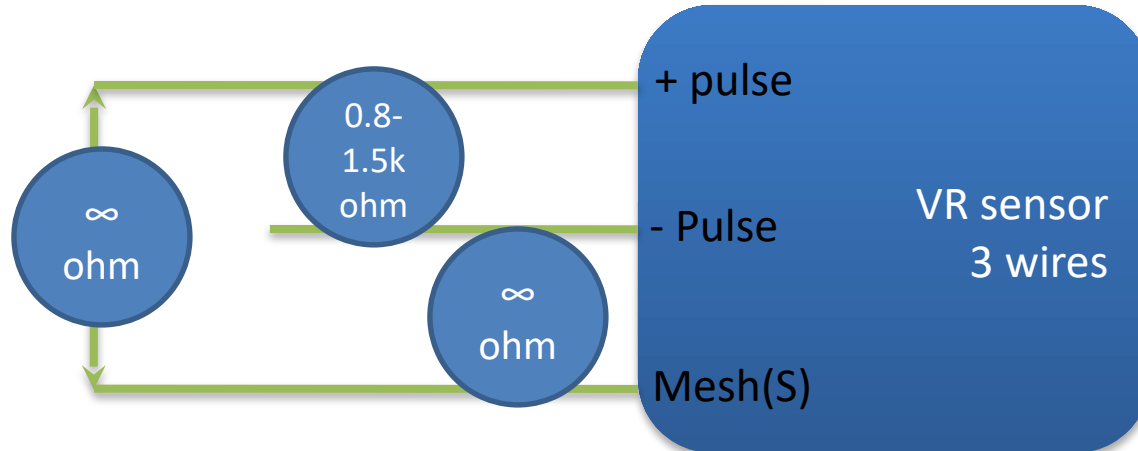

coil types

There are 2 types of coils, this small guide can indicate what type of coils we have.

In general it can be summed up that if the coil or coil pack has 12v and GND, it is a coil Smart, if it only has 12v OR GND (only one of the two) then it's Dumb coil.

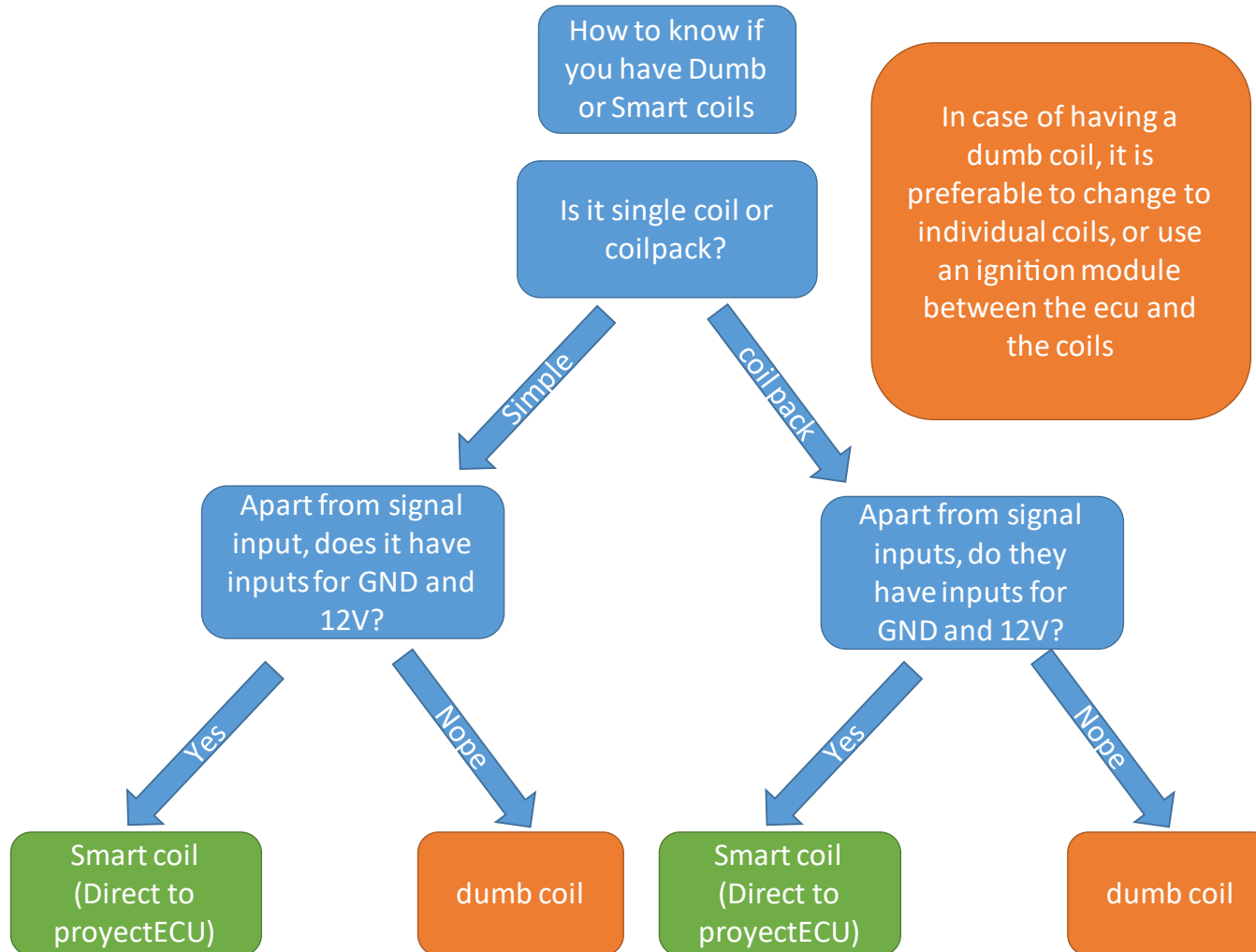

Ground Connection

The ground connection is VERY important, a bad connection can cause loss of communication with the ECU, sensors with voltage variation, or even damage to the wiring.

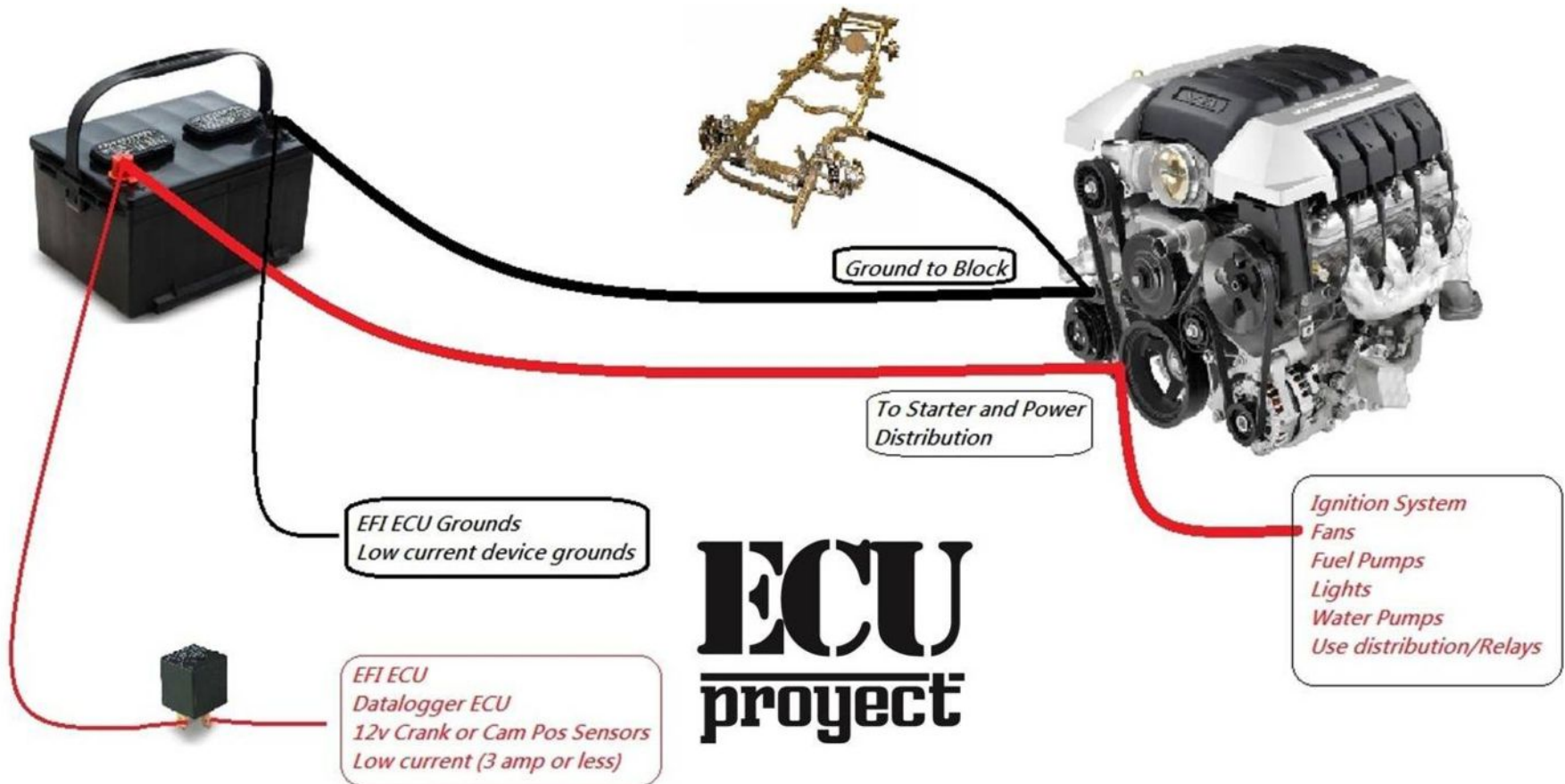

WB-connection

Wideband analog signal connection exists in 2 ways depending on your wideband kit, here we show 2 examples taking WB aem:



DIAGRAMA BASICO PROYECT ECU



ECU project

Use diagram as an example

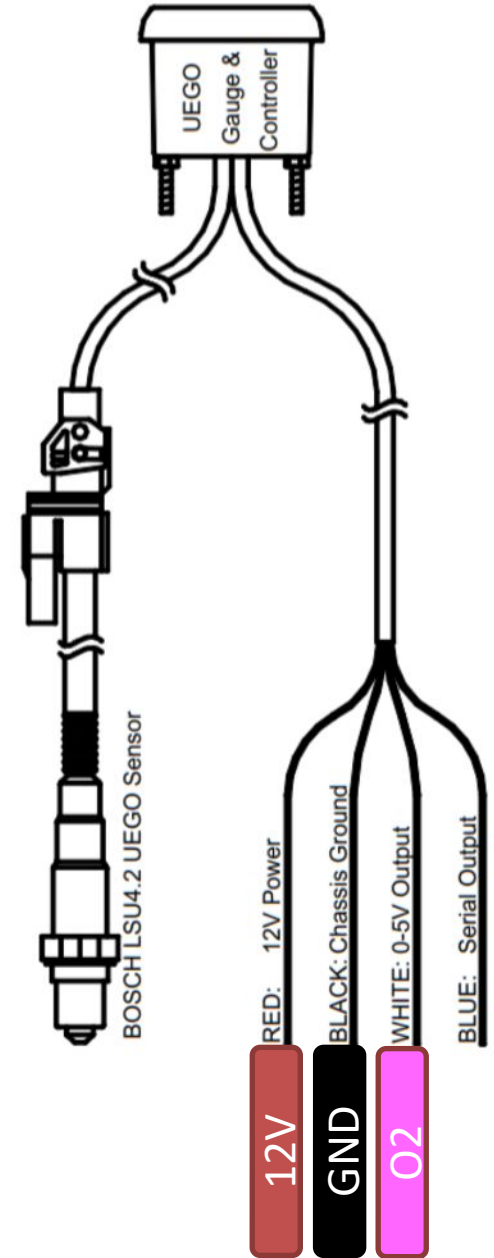
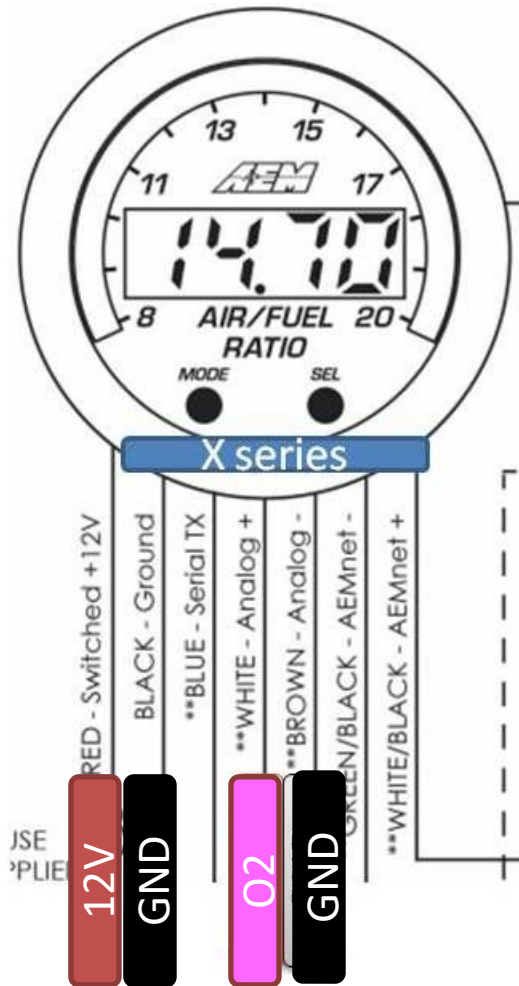
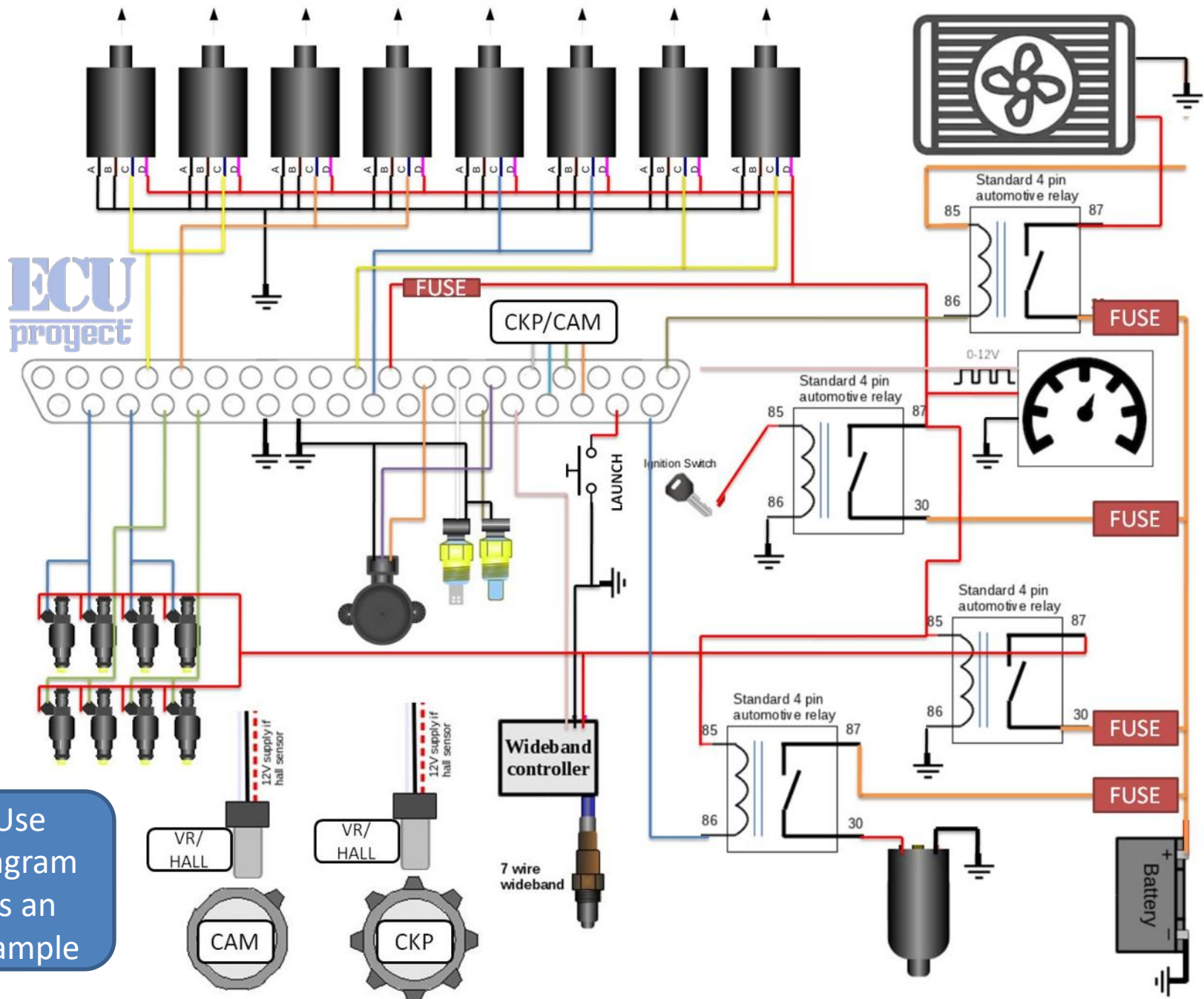
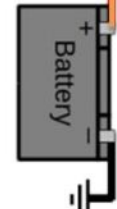
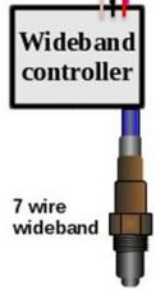
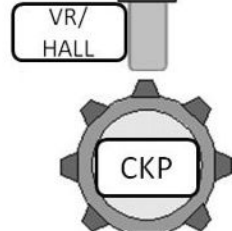
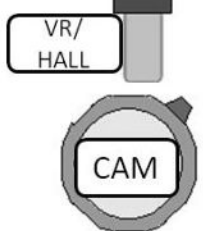

Bluetooth use (if available)

Power on the ECU

In the android device go to the bluetooth section, search and connect to the device "ProjectECU", the pin is: 1111

On the Android device go to the Play Store and search for "RealDash"

Install realdash APP

Once installed you have to open realdash and configure in your panel, Connections "ADD", Source "Speeduino", Type "Bluetooth", Bluetooth "ProjectECU", Settings "Serial 3" and DONE.

We can now enjoy data in Dash.



Available Video Tutorial:
ProjectECU.com/downloads

Tutorial how to connect to
ProjectECU Bluetooth from
cell/tablet

